

Viewing the Control Panel

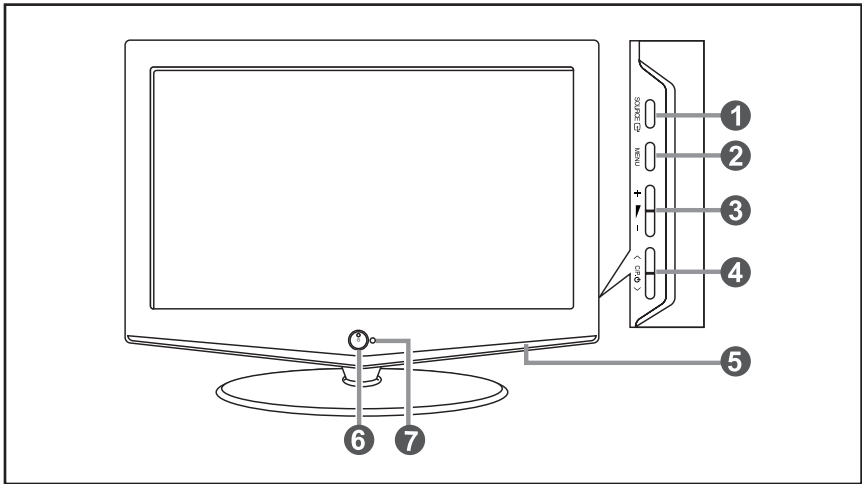

1 SOURCE

Toggles between all the available input sources (TV, Ext., AV, S-Video, PC, DVI).

In the on-screen menu, use this button as you use the **ENTER** button on the remote control.

2 MENU

Press to see an on-screen menu of your TV's features.

3 + -

Press to increase or decrease the volume.

In the on-screen menu, use the **+  -** buttons as you use the **◀** and **▶** buttons on the remote control.

4 < C/P. ϕ >

Press to change channels. In the on-screen menu, use the **< C/P. ϕ >** buttons as you use the **▲** and **▼** buttons on the remote control. (Without the Remote Control, You can turn on TV by using the Channel buttons.)

5 Speaker

6 (Power)

Press to turn the TV on and off.

Power Indicator

Blinks and turns off when the power is on and lights up in stand-by mode.

7 Remote Control Sensor

Aim the remote control towards this spot on the TV.

Viewing the Connection Panel

➤ The product colour and shape may vary depending on the model.

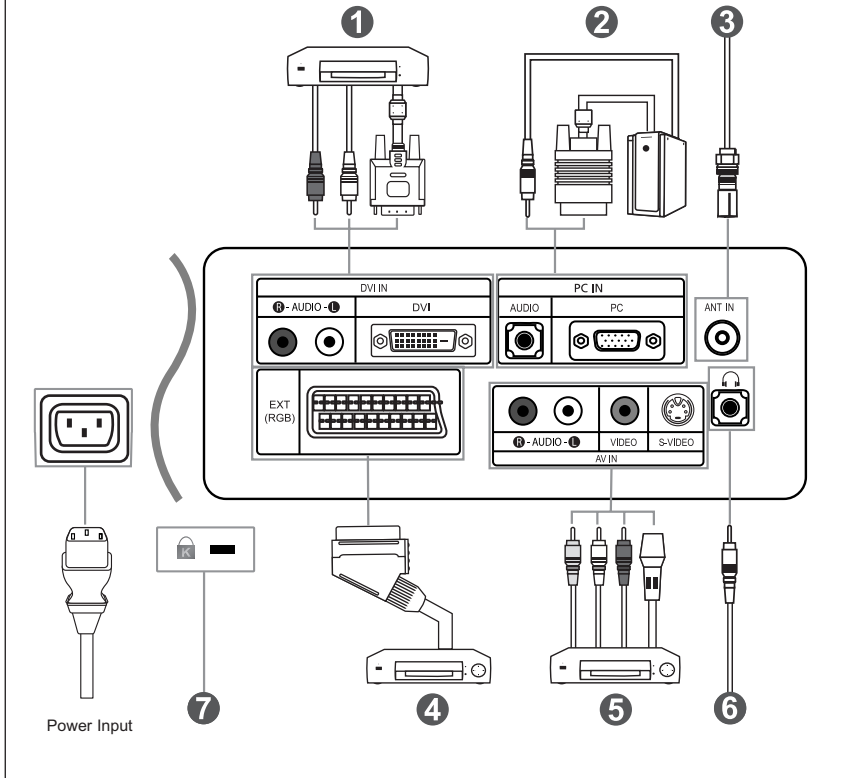

- Whenever you connect an external device to your TV, make sure that power on the unit is turned off.
- When connecting an external device, match the colour of the connection terminal to the cable.

1 Connecting DVI

- Connect the DVI connector to the DVD connector.
- Connect the stereo audio cable to "R - AUDIO - L" on the rear of your set and the other end to "Audio Out" of the sound card on your DVD.
- DVI does not support PC function.

2 Connecting Computer

- Connect the D- Sub cable (optional) to "PC (PC IN)" on the rear of your set and the other end to the Video Card of your computer.
- Connect the stereo audio cable (optional) to "AUDIO (PC IN)" on the rear of your set and the other end to "Audio Out" of the sound card on your computer.

3 Connecting an Aerial or Cable Television Network

- To view television channels correctly, a signal must be received by the set from one of the following sources:
- An outdoor aerial / A cable television network / A satellite network

4 Connecting Set-Top Box, VCR or DVD

- Connect the VCR or DVD SCART cable (optional) to the SCART connector of the VCR or DVD.
- If you wish to connect both the Set-Top Box and VCR (or DVD), you should connect the Set-Top Box to the VCR (or DVD) and connect the VCR (or DVD) to your set.

5 Connecting External AV Devices









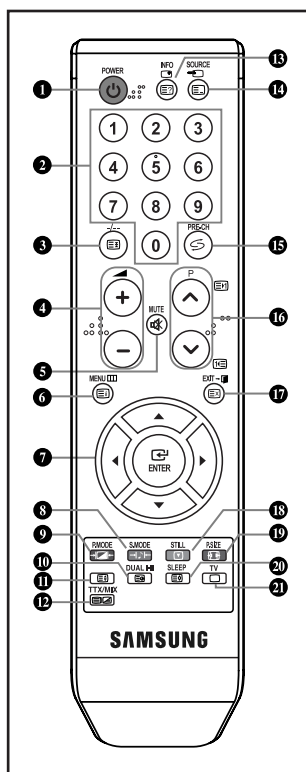



- Connect RCA (optional) or S-VIDEO cable (optional) to an appropriate external AV device such as VCR, DVD or Camcorder.
- Connect RCA audio cables (optional) to "R - AUDIO - L" on the rear of your set and the other ends to corresponding audio out connectors on the AV device.
- Headphone may be connected to the headphone output () on the rear of your set. While the headphone is connected, the sound from the built-in speakers will be disabled.

7 Kensington Lock

- The Kensington lock (optional) is a device used to physically fix the system when used in a public place.
- If you want to use a locking device, contact the dealer where you purchased the TV.

Viewing the Remote Control



- 1 Television Standby button
 - 2 Number buttons for direct channel access
 - 3 One/Two-digit channel selection
 - 4  : Volume increase
 : Volume decrease
 - 5 Temporary sound switch-off
 - 6 Menu display and change confirmation
 - 7 Control the cursor in the menu
 - 8 Sound mode selection
 - 9 Picture effect selection
 - 10 Sound effect selection
 - 11 Use to see information on the current broadcast
 - 12 Available source selection
 - 13 Previous channel
 - 14  : Next channel
 : Previous channel
 - 15 Previous channel
 - 16  : Next channel
 : Previous channel
 - 17 Exit the on screen menu
 - 18 Picture freeze
 - 19 Picture size selection
 - 20 Automatic Power-off
 - 21 Selects the TV mode directly
- Teletext Functions**
- 23 Teletext hold
 - 24 Teletext index
 - 25 Teletext sub page
 - 26 Teletext size selection
 - 27 Teletext display/mix both teletext information and the normal broadcast
 - 28 Teletext reveal
 - 29 Teletext mode selection (LIST/FLOF)
 - 30  : Teletext next page
 : Teletext previous page
 - 31 Teletext cancel
 - 32 Teletext store
 - 33 Exit from the teletext display
 - 34    
- Fastest topic selection

- > The performance of the remote control may be affected by bright light.
- > This is a special remote control for the visually impaired, and has Braille points on the Power, Channel and Volume buttons.

Installing Batteries in the Remote Control

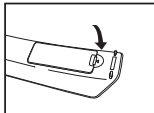
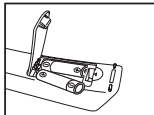
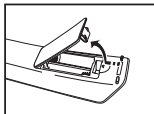



1. Lift the cover at the back of the remote control upward as shown in the figure.
2. Install two AAA size batteries.
 - Make sure to match the “+” and “-” ends of the batteries with the diagram inside the compartment.
3. Replace the cover.
 - Remove the batteries and store them in a cool, dry place if you won't be using the remote control for a long time. The remote control can be used up to about 23 feet from the TV. (Assuming typical TV usage, the batteries last for about one year.)

➤ **If the remote control doesn't work, check the following:**

1. Is the TV power on?
2. Are the plus and minus ends of the batteries reversed?
3. Are the batteries drained?
4. Is there a power outage, or is the power cord unplugged?
5. Is there a special fluorescent light or neon sign nearby?



Switching On and Off

The mains lead is attached to the rear of your set.

1. Plug the mains lead into an appropriate socket.
 - The standby indicator lights up on the front of the set.
2. Press the **⏻** button on the front of the set.
 - You also can press the **POWER** **⏻** button or the **TV** () button on the remote control to turn the TV on.
 - The programme that you were watching last is reselected automatically.
3. Press the numeric button (0-9) or channel up/down (/) button on the remote control or **< C/P ⏻ >** button on the right side of the panel.
 - When you switch the set on for the very first time, you will be asked to choose language in which the menus are to be displayed.
4. To switch your set off, press the **POWER** **⏻** button again.

Placing Your Television in Standby Mode

Your set can be placed in standby mode in order to reduce the power consumption. The standby mode can be useful when you wish to interrupt viewing temporarily (during a meal, for example).

1. Press the **POWER** **⏻** button on the remote control.
 - The screen is turned off and a standby indicator appears on the front of your set.
2. To switch your set back on, simply press the **POWER** **⏻** , numeric buttons (**0-9**) or channel up/down (/) button again.
 - Do not leave your set in standby mode for long periods of time (when you are away on holiday, for example). It is best to unplug the set from the mains and aerial.

Plug & Play

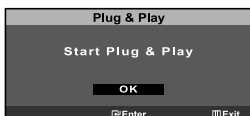

When the TV is initially powered on, several basic settings proceed automatically and subsequently. The following settings are available.

1. Press the **POWER** **⏻** button on the remote control. The message “Start Plug & Play” is displayed with “OK” selected. Press the **ENTER** button.
2. Select the appropriate language by pressing the **▲** or **▼** button. Press the **ENTER** button to confirm your choice.
3. The message “Check antenna input.” is displayed with “OK” selected. Press the **ENTER** button.
 - Please check that the antenna or cable TV is connected correctly.

4. Select the appropriate country by pressing the **▲** or **▼** button. Press the **ENTER** button to confirm your choice.
5. The "Auto Store" menu is displayed with the "Start" selected. Press the **ENTER** button.
 - The channel search will start and end automatically.
 - After all the available channels are stored, the "Clock Set" menu appears.
 - Press the **ENTER** button at any time to interrupt the memorization process.
6. Press the **ENTER** button. Select the "Hour" or "Minute" by pressing the **◀** or **▶** button. Set the "Hour" or "Minute" by pressing the **▲** or **▼** button.
 - You can also set the hour and minute by pressing the number buttons on the remote control.
7. Press the **ENTER** button to confirm your setting. The message "Enjoy your viewing." is displayed.

- ♦ **Language:** Select your language.
- ♦ **Country:** Select your country.
- ♦ **Auto Store:** Automatically scans for and stores channels available in the local area.
- ♦ **Clock Set:** Sets the current time for the TV clock.



If you want to reset this feature...

1. Press the **MENU** button to display the menu. Press the **▲** or **▼** button to select "Setup", then press the **ENTER** button.
2. Press the **ENTER** button to select "Plug & Play".
3. This message "Start Plug & Play" is displayed.

Storing Channels Automatically



You can scan for the frequency ranges available to you (and availability depends on your country). Automatically allocated programme numbers may not correspond to actual or desired programme numbers. However, you can sort numbers manually and clear any channels you do not wish to watch.



1. Press the **MENU** button to display the menu. Press the **▲** or **▼** button to select "Channel", then press the **ENTER** button.
2. Press the **ENTER** button to select "Country".
3. Select the appropriate country by pressing the **▲** or **▼** button. Press the **ENTER** button to confirm your choice.

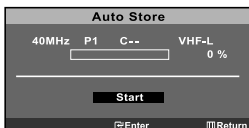

4. Press the **▲** or **▼** button to select "Auto Store", then press the **ENTER** button.
5. Press the **ENTER** button to select "Start".
 - The TV will begin memorizing all of the available channels.
 - Press the **ENTER** button at any time to interrupt the memorization process and return to the "Channel" menu.
6. After all the available channels are stored, the "Sort" menu appears.

Storing Channels Manually

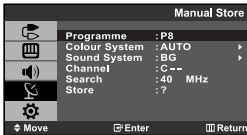

You can store up to 100 channels, including those received via cable networks. When storing channels manually, you can choose:

- ◆ Whether or not to store each of the channels found.
- ◆ The programme number of each stored channel which you wish to identify.

1. Press the **MENU** button to display the menu.
Press the **▲** or **▼** button to select "Channel", then press the **ENTER** button.
2. Press the **▲** or **▼** button to select "Manual Store", then press the **ENTER** button.
3. Press the **ENTER** button to select "Programme".
4. To assign a programme number to a channel, find the correct number by pressing the **▲** or **▼** button and then press the **ENTER** button.
 - You can also set a channel number by pressing number buttons on the remote control.
5. Press the **▲** or **▼** button to select "Colour System", then press the **ENTER** button.
6. Select the colour standard required by pressing the **▲** or **▼** button, then press the **ENTER** button.
7. Press the **▲** or **▼** button to select "Sound System", then press the **ENTER** button.
8. Select the sound standard required by pressing the **▲** or **▼** button, then press the **ENTER** button.
 - If there is an abnormal sound or no sound, re-select the sound system required.
9. If you know the number of the channel to be stored, press the **▲** or **▼** button to select "Channel". Press the **ENTER** button. Select **C** (Air channel) or **S** (Cable channel) by pressing the **▲** or **▼** button. Press the **▶** button to select channel. Select the required number by pressing the **▲** or **▼** button and then press the **ENTER** button.
 - Channel mode: **P** (Programme mode)
 - C** (Air channel mode)
 - S** (Cable channel mode)
 - You can also set a channel number by pressing the number buttons on the remote control.
10. If you do not know the channel numbers, press the **▲** or **▼** button to select "Search". Press the **ENTER** button.
Search by pressing the **▲** or **▼** button and then press the **ENTER** button.
11. Press the **▲** or **▼** button to select "Store", then press the **ENTER** button. Press the **▲** or **▼** button to select "OK", then press the **ENTER** button.
12. Repeat steps 3 to 11 for each channel to be stored.

- ◆ **Programme:** Selects a program number for the channel.
- ◆ **Colour System:** Sets the colour supporting system.
- ◆ **Sound System:** Sets the sound supporting system.
- ◆ **Channel:** Selects a channel.
- ◆ **Search:** Scans for the frequency value for the channel.
- ◆ **Store:** Saves your settings.

Editing the Channels



You can exclude the channels you chose from the channels you scanned. When you scan through the stored channels, those you have chosen to skip are not displayed.

All channels that you do not specifically choose to skip are displayed during scanning.

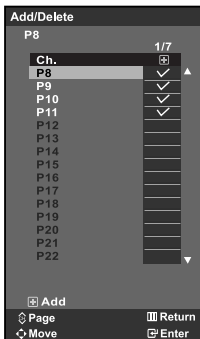

1. Use the number buttons to directly select the channel that will be added or deleted.
2. Press the **MENU** button to display the menu. Press the **▲** or **▼** button to select "Channel", then press the **ENTER** button.
3. Press the **▲** or **▼** button to select "Add/Delete", then press the **ENTER** button.
4. Press the **▲** or **▼** button to select channels to be deleted or added.
5. Press the **▶** button to select "☐" column, then press the **ENTER** button.
 - The channels marked with "✓" will be added.
6. Press the **EXIT** button to exit.
 - You can view any channel (including an erased channel) by using the number buttons on the remote control.

Sorting the Stored Channels



You can exchange the numbers of two channels, in order to:

- ◆ **Modify the numeric order in which the channels have been automatically stored.**
- ◆ **Give easily remembered numbers to the channels that you watch most often.**



1. Press the **MENU** button to display the menu. Press the **▲** or **▼** button to select "Channel", then press the **ENTER** button.
2. Press the **▲** or **▼** button to select "Sort", then press the **ENTER** button.
3. Press the **ENTER** button to select "From". Press the **▲** or **▼** button until the channel number that you wish to change is displayed. Press the **ENTER** button.
4. Press the **▲** or **▼** button to select "To", then press the **ENTER** button. Press the **▲** or **▼** button until the new number by which you wish to identify the channel is displayed. Press the **ENTER** button.
5. Press the **▲** or **▼** button to select "Store", then press the **ENTER** button. Press the **▲** or **▼** button to select "OK", then press the **ENTER** button.
 - The selected channel is exchanged with the one previously stored to the chosen number.
6. Repeat steps 3 to 5 for another channel to be sorted.
7. Press the **EXIT** button to exit.

Assigning Channels Names



Channel names will be assigned automatically when channel information is broadcast. These names can be changed, allowing you to assign new names.

1. Press the **MENU** button to display the menu. Press the **▲** or **▼** button to select "Channel", then press the **ENTER** button.
2. Press the **▲** or **▼** button to select "Name", then press the **ENTER** button.
3. If necessary, select the channel to be assigned to a new name by pressing the **▲** or **▼** button. Press the **ENTER** button.

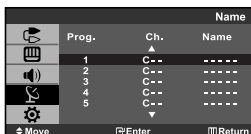

To...	Then...
Select a letter, number or symbol	Press the ▲ or ▼ button
Move on the next letter	Press the ▶ button
Move back the previous letter	Press the ◀ button
Confirm the name	Press the ENTER button

➤ The characters available are : Letters of the alphabet (A~Z)
Numbers (0-9)
Special characters (-, space)

5. Repeat steps 3 to 4 for each channel to be assigned to a new name.
6. Press the **EXIT** button to exit.

Fine Tuning Channel Reception



Use fine tuning to manually adjust a particular channel for optimal reception.



1. Use the number buttons to directly select the channel that you want to fine tune.
2. Press the **MENU** button to display the menu. Press the **▲** or **▼** button to select "Channel", then press the **ENTER** button.
3. Press the **▲** or **▼** button to select "Fine Tune", then press the **ENTER** button.
4. Press the **◀** or **▶** button to adjust the fine tuning. Press the **ENTER** button.
5. Press the **EXIT** button to exit.

➤ Fine tuned channels that have been saved are marked with an asterisk "*" on the right-hand side of the channel number in the channel banner. And the channel number turns red.
➤ To reset the fine-tuning, select "Reset" by pressing the **▲** or **▼** button and then press the **ENTER** button.

Changing the Picture Standard

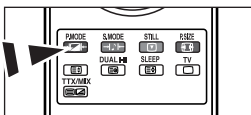
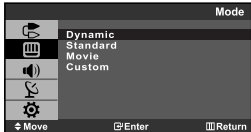

You can also press the **P.MODE** button on the remote control to select one of the picture settings.

You can select the type of picture which best corresponds to your viewing requirements.

1. Press the **MENU** button to display the menu. Press the **▲** or **▼** button to select "Picture", then press the **ENTER** button.
2. Press the **ENTER** button to select "Mode".
3. Press the **▲** or **▼** button to select the desired picture effect. Press the **ENTER** button.
4. Press the **EXIT** button to exit.

- **Dynamic:** Selects the picture for high-definition in a bright room.
- **Standard:** Selects the picture for optimum display in a normal environment.
- **Movie:** Selects the picture for comfortable display in a dark room.
- **Custom:** Select to view your favorite display settings.
(Refer to "Adjusting the Custom Picture")

[PC mode]

- **Entertain:** High brightness. (For watching motion pictures such as a DVD or Video CD.)
- **Internet:** Medium brightness. (For working with a mixture of images such as text and graphics.)
- **Text:** Normal brightness. (For documentations or works involving heavy text.)
- **Custom:** Select to view your favorite display settings.

- The Picture mode must be adjusted separately for each input source.
- In the PC mode, "Entertain", "Internet", "Text", "Custom" appears.

Adjusting the Custom Picture



Your set has several settings which allow you to control picture quality.

1. Press the **MENU** button to display the menu. Press the **▲** or **▼** button to select "Picture", then press the **ENTER** button.
2. Press the **▲** or **▼** button to select "Custom", then press the **ENTER** button.
3. Press the **▲** or **▼** button to select a particular item. Press the **ENTER** button.
4. Press the **◀** or **▶** button to decrease or increase the value of a particular item. Press the **ENTER** button.
5. Press the **EXIT** button to exit.

- **Contrast:** Adjusts the lightness and darkness between objects and the background.
- **Brightness:** Adjusts the brightness of the whole screen.
- **Sharpness:** Adjusts the outline of objects to either sharpen them or make them more dull.
- **Colour:** Adjusts the colours, making them lighter or darker.

- If you make any changes to these settings, the picture mode is automatically switched to "Custom".
- In the PC mode, only "Contrast" and "Brightness" can be adjusted.

Changing the Colour Tone

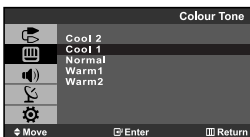
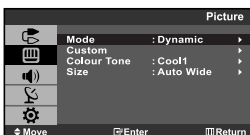

You can select the most comfortable colour tone to your eyes.

1. Press the **MENU** button to display the menu. Press the **▲** or **▼** button to select "Picture", then press the **ENTER** button.
2. Press the **▲** or **▼** button to select "Colour Tone", then press the **ENTER** button.
3. Press the **▲** or **▼** button to select the desired colour tone setting. Press the **ENTER** button.
4. Press the **EXIT** button to exit.

- ◆ **Cool 2:** Makes the colour temperature bluer than "Cool 1" menu.
- ◆ **Cool 1:** Makes whites bluish.
- ◆ **Normal:** Keeps whites white.
- ◆ **Warm1:** Makes whites reddish.
- ◆ **Warm2:** Makes the colour temperature redder than "Warm1" menu.

➤ In the PC mode, "Cool", "Normal", "Warm", "Custom" appears.

Changing the Picture Size

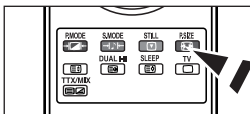
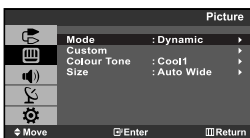

You can select the picture size which best corresponds to your viewing requirements.

1. Press the **MENU** button to display the menu. Press the **▲** or **▼** button to select "Picture", then press the **ENTER** button.
2. Press the **▲** or **▼** button to select "Size", then press the **ENTER** button.
3. Select the required option by pressing the **▲** or **▼** button. Press the **ENTER** button.
4. Press the **EXIT** button to exit.

- ◆ **Auto Wide:** Automatically adjusts the picture size to the "Wide" aspect ratio.
- ◆ **Wide:** Adjusts the picture size to Wide appropriate for DVDs or wide broadcasting.
- ◆ **Zoom:** Magnifies the Wide picture (in the vertical direction) to fit the screen size.
- ◆ **4:3:** This is the default setting for a video movie or normal broadcasting.

➤ In the PC and DVI mode, only "Wide" and "4:3" mode can be adjusted. (The "Zoom", "Auto Wide" mode is not supported.)

➤ **Zoom:** Select **[P.SIZE]** by pressing the **◀** or **▶** buttons.

Use the **▲** or **▼** button to move the picture up and down.

After selecting **[P.SIZE]**, use the **▲** or **▼** button to magnify or reduce the picture size in the vertical direction.

[P.SIZE] You can select these options by simply pressing the **P.SIZE** button on the remote control.

Adjusting the Colour Control



Adjust the individual R, G, B Colour Controls.

1. Press the **MENU** button to display the menu. Press the **▲** or **▼** button to select "Picture", then press the **ENTER** button.
2. Press the **▲** or **▼** button to select "Colour Control", then press the **ENTER** button.
3. Press the **▲** or **▼** button to select a particular item. Press the **ENTER** button.
4. Press the **◀** or **▶** button to decrease or increase the value of a particular item. Press the **ENTER** button.
5. Press the **EXIT** button to exit.

➤ Available in PC Mode Only.



Freezing the Picture

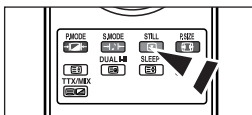

1. Press the **STILL** button to freeze a moving picture.
 - Normal sound will still be heard. Press it again to cancel.
 - This function doesn't work when the input Source is DVI, and PC.

Changing the Sound Standard

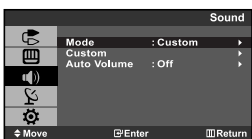

You can select the type of the special sound effect to be used when watching a given broadcast.

1. Press the **MENU** button to display the menu. Press the **▲** or **▼** button to select "Sound", then press the **ENTER** button.
2. Press the **ENTER** button to select "Mode".
3. Press the **▲** or **▼** button to select the desired sound effect. Press the **ENTER** button.
4. Press the **EXIT** button to exit.

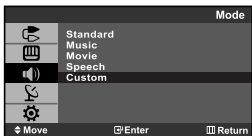

- **Standard**: Selects the normal sound mode.
- **Music**: Emphasizes music over voices.
- **Movie**: Provides live and full sound for movies.
- **Speech**: Emphasizes voices over other sounds.
- **Custom**: Selects your custom sound settings.

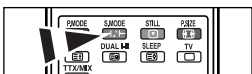

You can also select these options by simply pressing the **S.MODE** button on the remote control.

Customizing the Sound

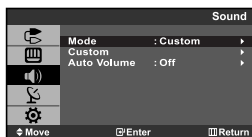

The sound settings can be adjusted to suit your personal preferences. (Alternatively, you can use one of the "automatic" settings.)



1. Press the **MENU** button to display the menu. Press the **▲** or **▼** button to select "Sound", then press the **ENTER** button.
2. Press the **▲** or **▼** button to select "Custom", then press the **ENTER** button.
3. Press the **▲** or **▼** button to select a particular item. Press the **ENTER** button.
4. Press the **◀** or **▶** button to decrease or increase the value of a particular item. Press the **ENTER** button.
5. Press the **EXIT** button to exit.

➤ If you make any changes to the "automatic" settings, the sound mode is automatically switched to the "Custom" mode.

Selecting the Sound mode

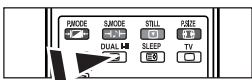

You can set the sound mode by pressing the "DUAL I-II" button. When you press it, the current sound mode is displayed on the screen.

You can also set these options simply by pressing the **DUAL I-II** button on remote control.

	Audio Type	DUAL 1/2	Default
FM Stereo	Mono	MONO	Automatic change
	Stereo	STEREO ↔ MONO	
	Dual	DUAL 1 ↔ DUAL 2	DUAL 1
NICAM Stereo	Mono	MONO	Automatic change
	Stereo	MONO ↔ STEREO	
	Dual	↔ MONO ↔ DUAL 1 DUAL 2 ↔	DUAL 1

Adjusting the Volume Automatically

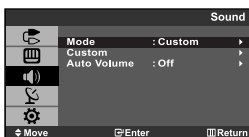

Each broadcasting station has its own signal conditions, and so it is not easy for you to adjust the volume every time the channel is changed. This feature let you automatically adjust the volume of the desired channel by lowering the sound output when the modulation signal is high or by raising the sound output when the modulation signal is low.



1. Press the **MENU** button to display the menu. Press the **▲** or **▼** button to select "Sound", then press the **ENTER** button.
2. Press the **▲** or **▼** button to select "Auto Volume", then press the **ENTER** button.
3. Press the **▲** or **▼** button to select "On" or "Off". Press the **ENTER** button.
4. Press the **EXIT** button to exit.

Setting and Displaying the Current Time



You can set the TV's clock so that the current time is displayed when you press the **INFO** button. You must also set the time if you wish to use the automatic On/Off timers.



1. Press the **MENU** button to display the menu. Press the **▲** or **▼** button to select "Setup", then press the **ENTER** button.
2. Press the **▲** or **▼** button to select "Time", then press the **ENTER** button.
3. Press the **ENTER** button to select "Clock Set".

4.

To...	Press the...
Move to "Hour" or "Minute"	◀ or ▶ button.
Set the "Hour" or "Minute"	▲ or ▼ button.
Press the ENTER button.	

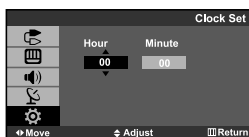

5. Press the **EXIT** button to exit.
 - > If you disconnect the power cord, you have to set the clock again.
 - > You can also set hour and minute by pressing the number buttons on the remote control.

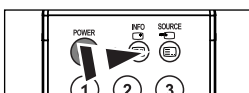

Setting the Sleep Timer



You can select a time period of between 30 and 180 minutes after which the television automatically switches to standby mode.

1. Press the **MENU** button to display the menu. Press the **▲** or **▼** button to select "Setup", then press the **ENTER** button.
2. Press the **▲** or **▼** button to select "Time", then press the **ENTER** button.
3. Press the **▲** or **▼** button to select "Sleep Timer", then press the **ENTER** button.
4. Press the **▲** or **▼** button repeatedly until the desired time appears (Off, 30, 60, 90, 120, 150, 180). Press the **ENTER** button.
 - The TV automatically switches to standby mode when the timer reaches 0.
5. Press the **EXIT** button to exit.

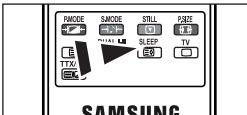
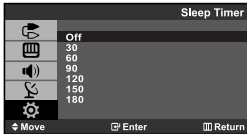

1. Press the **SLEEP** button on the remote control repeatedly until the appropriate time interval appears.

Switching the Television On and Off Automatically



You can set the On/Off timers so that the set will:

- ◆ Switch on automatically and tune to the channel of your choice at the time you select.
- ◆ Switch off automatically at the time you select.

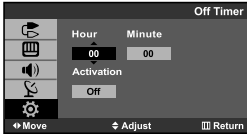
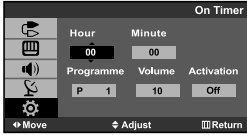

1. Press the **MENU** button to display the menu. Press the **▲** or **▼** button to select "Setup", then press the **ENTER** button.
2. Press the **▲** or **▼** button to select "Time", then press the **ENTER** button.
3. Press the **▲** or **▼** button to select "On Timer", then press the **ENTER** button.
4. Press the **▲** or **▼** button to adjust "Hour", then press the **▶** button to move to the next step. Set other items using the same method as above. When finished, press the **ENTER** button to return.
5. Press the **▲** or **▼** button to select "Off Timer", then press the **ENTER** button.
6. Press the **▲** or **▼** button to adjust "Hour", then press the **▶** button to move to the next step. Set other items using the same method as above. When finished, press the **ENTER** button to return.
7. Press the **EXIT** button to exit.
 - The first step is to set the television's clock.
(refer to "Setting and Displaying the Current Time" on page 15)
 - You can also set hour and minute by pressing the number buttons on the remote control.
 - The "Activation" setting must be set to "On" in order for the timers to work.

Choosing Your Language



When you start using your set for the first time, you must select the language which will be used for displaying menus and indications.

1. Press the **MENU** button to display the on-screen menu. Press the **▲** or **▼** button to select "Setup", then press the **ENTER** button.
2. Press the **▲** or **▼** button to select "Language", then press the **ENTER** button.
3. Select a particular language by pressing the **▲** or **▼** button repeatedly. Press the **ENTER** button.
 - You can choose one of 15 languages.
4. Press the **EXIT** button to exit.

Setting the Blue Screen Mode



If no signal is being received or the signal is very weak, a blue screen automatically replaces the noisy picture background. If you wish to continue viewing the poor picture, you must set the "Blue Screen" mode to "Off".



1. Press the **MENU** button to display the menu. Press the **▲** or **▼** button to select "Setup", then press the **ENTER** button.
2. Press the **▲** or **▼** button to select "Blue Screen" then press the **ENTER** button.
3. Press the **▲** or **▼** button to select "On" or "Off". Press the **ENTER** button.
4. Press the **EXIT** button to exit.

Selecting the Source







You can select among external sources connected to your TV's input jacks.

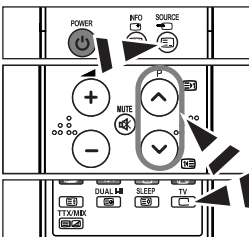

1. Press the **MENU** button to display the menu. Press the **ENTER** button to select "Input".
2. Press the **ENTER** button to select "Source List".
3. Select the required device by pressing the **▲** or **▼** button. Press the **ENTER** button.
 - You can only select a source if it is connected to your TV.



-  Press the **SOURCE** button on the remote control to toggle between all the available source. TV mode can be selected by pressing the **TV**  or **P**  /  button on the remote control but you cannot select it by pressing the **SOURCE** button.

Editing the Input Source Names

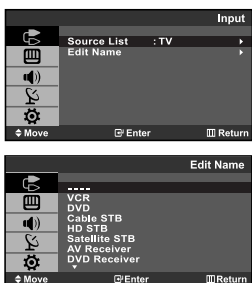

Name the device connected to the input jacks to make your input source selection easier.

1. Press the **MENU** button to display the menu.
Press the **ENTER** button, to select "Input".
2. Press the **▲** or **▼** button to select "Edit Name", then press the **ENTER** button.
3. Press the **▲** or **▼** button to select the device that you wish to edit.
Press the **ENTER** button.
4. Press the **▲** or **▼** button to select the required device.
Press the **ENTER** button.
 - The following options are available:
 - - VCR - DVD - Cable STB - HD STB - Satellite STB - AV Receiver - DVD Receiver - Game - Camcorder - DVD Combo - DHR - PC
 - DHR: DVD HDD Recorder
5. Press the **EXIT** button to exit.

Teletext Decoder

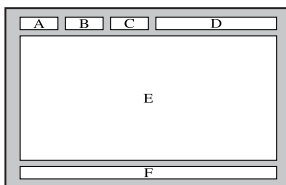

Most set channels carry "teletext", pages of written information that provide information such as:

- ◆ **Television programme times.**
- ◆ **News bulletins and Weather forecasts.**
- ◆ **Sports results.**
- ◆ **Subtitles for the hard of hearing.**

The teletext pages are organized according to six categories:

Part	Contents
A	Selected page number.
B	Broadcasting station identity.
C	Current page number or search status.
D	Date and time.
E	Text.
F	Status information.

Displaying the Teletext Information

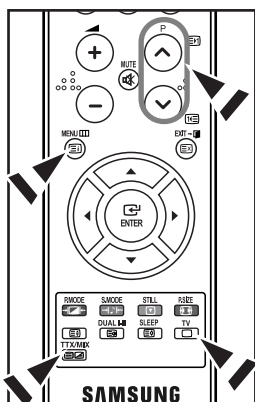

You can display teletext information at any time, but signal reception must be good. Otherwise:

- ◆ *Information may be missing.*
- ◆ *Some pages may not be displayed.*

To activate the teletext mode and display the contents page:

1. Using the **P** () or **P** () button, select the channel providing the teletext service.
2. Press the **TTX/MIX** () button to activate the teletext mode.
 - The contents page is displayed. It can be redisplayed at any time by pressing the **MENU** () button.
3. Press the **TTX/MIX** () button again.
 - The actual broadcast will be displayed simultaneously with the teletext page on the screen.
4. Press the **TV** () button again to exit from the Text display.
 - If any broken character appears while Text is being viewed, make sure that the Text language is identical with the language in the "Setup" menu mode. If both languages are different, select the same language with the Text language on the "Setup" menu.

Selecting a Specific Teletext Page

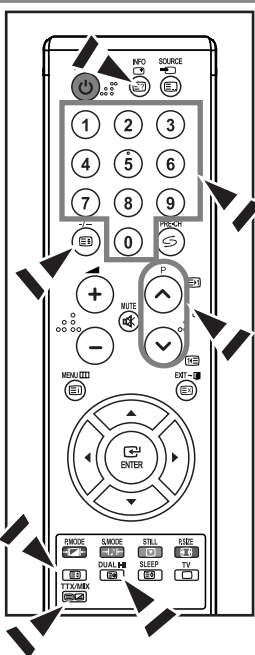

Press the number buttons on the remote control to enter the page number directly:



1. Enter the three-digit page number listed in the contents by pressing the corresponding numeric buttons.
2. If the selected page is linked with several secondary pages, the secondary pages are displayed in sequence. To freeze the display on a given page, press the **-/-** () button. Press the **-/-** () button again to resume.
3. Using the various display options:

To display...	Press the...
Both Teletext information and the normal broadcast	TTX/MIX ()
Hidden text (answers to quiz games, for example)	INFO ()
The normal screen	INFO ()
A secondary page, by entering its 4-digit number	DUAL I-II ()
The next page	P ()
The previous page	P ()
Double-size letters in the: <ul style="list-style-type: none"> • Upper half of the screen • Lower half of the screen 	() <ul style="list-style-type: none"> • Once • Twice
Normal screen	• Three times

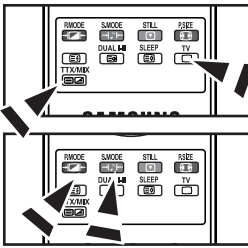
Using Fastext to Select a Teletext Page





The various topics included in the teletext pages are colour-coded, and can be selected by pressing the coloured buttons on the remote control.

1. Display the teletext contents page by pressing the **TTX/MIX** ( / ) button.
2. Press the coloured button corresponding to the topic that you wish to select (The available topics are listed on the status information line).
3. Press the Red button to display the previous page.
Press the Green button to display the next page.
4. Press the **TV** () button again to exit from the Text display.

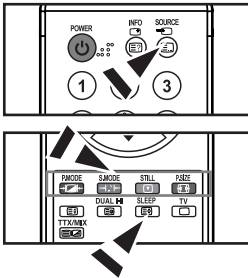
Storing Teletext Pages



You can store up to four teletext pages to display them later at leisure.

1. Select the LIST mode using the **SOURCE** () button.
 - The **SOURCE** () button is used to switch between the LIST and FLOF modes.
2. Press the coloured button corresponding to the page that will be replaced.
3. Enter the new page number using the numeric buttons.
4. Repeat steps 2 and 3 for each page to be stored, using a different coloured button each time.
5. Press the **SLEEP** () button until the corresponding blocks blink.

Setting up Your PC Software (Based on Windows XP)

The Windows display-settings for a typical computer are shown below. The actual screens on your PC may be different depending upon your particular version of Windows and your particular video card. Even if your actual screens look different, the same, basic set-up information will apply in almost all cases. (If not, contact your computer manufacturer or Samsung Dealer.)

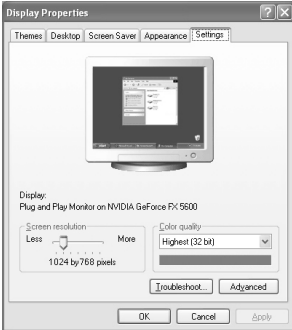

1. First, click on "Control Panel" on the Windows start menu.
2. When the control panel window appears, click on "Appearance and Themes" and a display dialog-box will appear.
3. When the control panel window appears, click on "Display" and a display dialog-box will appear.
4. Navigate to the "Settings" tab on the display dialog-box. The correct size setting (resolution):

Optimum - 1440 X 900

If a vertical-frequency option exists on your display settings dialog box, the correct value is "60" or "60 Hz". Otherwise, just click "OK" and exit the dialog box.

Display Modes

Both screen position and size will vary depending on the type of PC monitor and its resolution.

The resolutions in the table are recommended.

(All resolutions between the supported limits are supported)

Mode	Resolution	Horizontal Frequency (kHz)	Vertical Frequency (Hz)	Pixel Clock Frequency (MHz)	Sync Polarity (H/V)
IBM	720 x 400	31.469	70.087	28.322	- / +
	640 x 480	31.469	59.940	25.175	- / -
VESA	640 x 480	37.861	72.809	31.500	- / -
	640 x 480	37.500	75.000	31.500	- / -
	800 x 600	37.879	60.317	40.000	+ / +
	800 x 600	48.077	72.188	50.000	+ / +
	1024 x 768	48.363	60.004	65.000	- / -
	1024 x 768	56.476	70.069	75.000	- / -
	1024 x 768	60.023	75.029	78.750	+ / +
	1280 x 1024	63.981	60.020	108.000	+ / +
1280 x 1024	79.976	75.025	135.000	+ / +	
	1440 x 900	70.635	74.984	136.750	- / +

- The interlace mode is not supported.
- The set might operate abnormally if a non-standard video format is selected.
- DVI does not support PC function.

Setting the PC

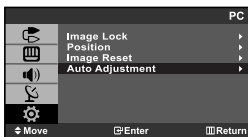
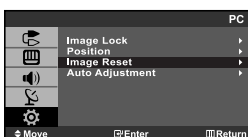
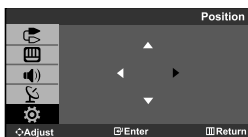
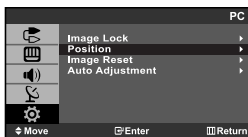
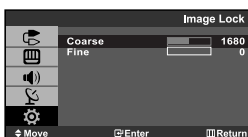
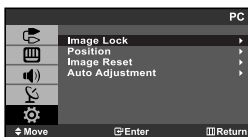

Image Lock:

The purpose of picture quality adjustment is to remove or reduce picture noise. If the noise is not removed by Fine-tuning alone, then adjust the frequency as best as possible (coarse) and Fine-tune again. After the noise has been reduced, re-adjust the picture so that it is aligned on the center of screen.

1. Preset: Press the **SOURCE** button to select PC mode.
2. Press the **MENU** button to display the menu. Press the **▲** or **▼** button to select "Setup", then press the **ENTER** button.
3. Press the **▲** or **▼** button to select "PC", then press the **ENTER** button.
4. Press the **ENTER** button to select "Image Lock".
5. Press the **▲** or **▼** button to select "Coarse" or "Fine", then press the **ENTER** button.
6. Press the **◀** or **▶** button to adjust the screen quality. Press the **ENTER** button.
7. Press the **EXIT** button to exit.

Position:

Adjust the PC's screen positioning if it does not fit the TV screen.

1. Press the **MENU** button to display the menu. Press the **▲** or **▼** button to select "Setup", then press the **ENTER** button.
2. Press the **▲** or **▼** button to select "PC", then press the **ENTER** button.
3. Press the **▲** or **▼** button to select "Position", then press the **ENTER** button.
4. Press the **▲** or **▼** button to adjust the V-Position (Vertical-Position). Press the **◀** or **▶** button to adjust the H-Position (Horizontal-Position). Press the **ENTER** button.
5. Press the **EXIT** button to exit.

Image Reset:

You can replace all image settings with the factory default values.

1. Press the **MENU** button to display the menu. Press the **▲** or **▼** button to select "Setup", then press the **ENTER** button.
2. Press the **▲** or **▼** button to select "PC", then press the **ENTER** button.
3. Press the **▲** or **▼** button to select "Image Reset", then press the **ENTER** button.
4. Press the **EXIT** button to exit.

Auto Adjustment:

Auto adjustment allows you to set the TV to self-adjust to the incoming PC video signal. The fine, coarse and position values are adjusted automatically.

1. Press the **MENU** button to display the menu. Press the **▲** or **▼** button to select "Setup", then press the **ENTER** button.
2. Press the **▲** or **▼** button to select "PC", then press the **ENTER** button.
3. Press the **▲** or **▼** button to select "Auto Adjustment", then press the **ENTER** button.
4. Press the **EXIT** button to exit.

How to Adjust the Stand

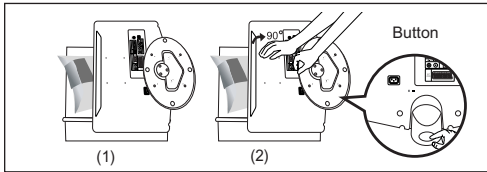

1. Place the front of the TV onto a soft cloth or cushion on a table as in Figure (1).
- Align the TV bottom along the table edge.
2. Press on the center of the TV back. Adjust the stand as in Figure (2) while pressing the button on the back of the stand.
3. Place the TV on the table so that the TV sits safely.

How to Adjust the Angle of the TV

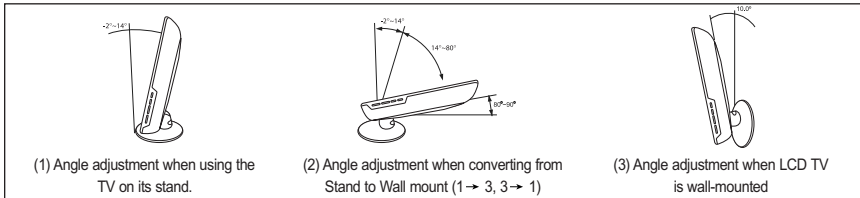

☛ When you adjust the stand, press the button on the back of the stand.

1. Figure (1) shows the adjustment angle ($-2^{\circ}\sim 14^{\circ}$) when you use the LCD on its stand. Excessive tilting can turn the LCD TV over which may cause damage.
2. Figure (2) shows the adjustment angle ($14^{\circ}\sim 80^{\circ}$) when you convert the LCD from stand-based use to wall-mount.
3. Figure (3) shows the adjustment angle ($0^{\circ}\sim 10^{\circ}$) when you mount the LCD TV to a wall.

➤ You will hear a "Click" sound when changing the angle from 1 to 2 or 3 to 2.

Installing the Wall Mount Kit

Wall mount items (sold separately) allow you to mount the TV on the wall. For the detailed information on installing the Wall Mount, see the instruction in the Wall Mount items. Contact a technician for installing the wall bracket. Samsung Electronics is not responsible for any damage to the product or injury to yourself or others if you elect to install the TV on your own.

Installing VESA compliant mounting devices

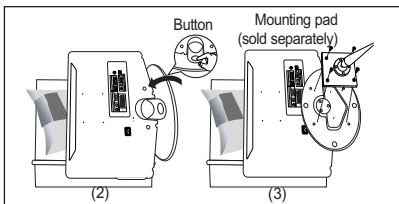

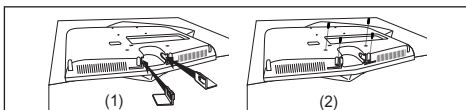

1. Place the TV down on a soft cloth or cushion on a table.
2. Adjust the stand, pressing the button on the back of the stand.
3. Align the mounting interface pad (not supplied) with the holes in the stand bottom and secure it with the four screws that come with the arm-type base, wall mount hanger or other bases (not supplied).

Using the Decoration Covers



1. When installing the TV on the wall without using the stand, insert decoration covers into the holes as described in the picture (1).
2. After inserting the decoration covers, fasten them with 4 screws as described in the picture (2).

Troubleshooting: Before Contacting Service Personnel

No sound or picture	<ul style="list-style-type: none"> • Check that the mains lead has been connected to a wall socket. • Check that you have pressed the  button on the front of the set. • Check the picture contrast and brightness settings. • Check the volume.
Normal picture but no sound	<ul style="list-style-type: none"> • Check the volume. • Check whether the MUTE  button has been pressed on the remote control.
No picture or black and white picture	<ul style="list-style-type: none"> • Adjust the colour settings. • Check that the broadcast system selected is correct.
Sound and picture interference	<ul style="list-style-type: none"> • Try to identify the electrical appliance that is affecting the set and move it further away. • Plug your set into a different mains socket.
Blurred or snowy picture, distorted sound	<ul style="list-style-type: none"> • Check the direction, location and connections of your aerial. This interference is often due to the use of an indoor aerial.
Remote control malfunctions	<ul style="list-style-type: none"> • Replace the remote control batteries. • Clean the upper edge of the remote control (transmission window). • Check the battery terminals.
"Check signal cable." message is displayed.	<ul style="list-style-type: none"> • Check that the signal cable is firmly connected to the PC or video sources. • Check that the PC or video sources are turned on.
On PC mode, "Mode Not Supported." message is displayed.	<ul style="list-style-type: none"> • Check the maximum resolution and the frequency of the video adaptor. • Compare these values with the data in the Display Modes.

The TFT LCD panel uses a panel consisting of sub pixels (3,888,000) which require sophisticated technology to produce. However, there may be few bright or dark pixels on the screen. These pixels will have no impact on the performance of the product.

Technical and Environmental Specifications

Model Name	LE19R7
Screen Size (Diagonal)	19 inches
Power Supply	AC 220-240 V, 50 Hz
Power Consumption	45W
PC Resolution	1440 x 900 @ 60Hz
Sound Output	3W x 2
Dimension (WxDxH)	
Body	485 x 58 x 369 mm
With stand	485 x 200 x 408 mm
Weight	
With stand	5.6 kg
Environmental Considerations	
Operating Temperature	10 °C to 40 °C (50 °F to 104 °F)
Operating Humidity	10% to 80%, non-condensing
Storage Temperature	-20 °C to 45 °C (-4 °F to 113 °F)
Storage Humidity	5% to 95%, non-condensing

- Design and specifications are subject to change without prior notice.
- This device is a Class B digital apparatus.